





BPOWER BCL14-12

The BCL series batteries are made in the AGM technology, designed for heavy cyclic work. Thanks the use of special carbon additives BCL series batteries have greater load accepting and require less time charging. They are characterized by efficiency and reliability and have a very long cyclic life of 700 cycles at a discharge depth of up to 80%.

BASIC PARAMETERS		OPERATING TEMPERATURE RANGE	
Nominal Voltage	12V	Storage Temperature Range	-15°C ~ 40°C
Nominal Capacity	14Ah	Charge Temperature Range	0°C ~ 40°C
Technology	VRLA AGM	Discharge Temperature Range	- 20°C ~ 55°C
Container Material	ABS UL94 HB		
PHYSICAL PARAMETERS		CHARGING CURRENT	
Dimensions (L x W x H)	151 x 99 x 100 (mm)	Recommended	1.4A
Weight	4,00kg		
Terminal	M5	Maximum	2.8A
Cell layout	1		
RATED CAPACITY (25°C)		CHARGING VOLTAGE (25°C)	
14,0 Ah	20hr	Cyclic work	14,70V - 14,90V
13,5 Ah	10hr		
12,0 Ah	5hr		

- 

Cycle life
Long cycle life (700 cycles at 80% DOD). Strong recovery ability of deep discharge.
- 

Tight construction
Reliable sealing structure ensures no leakage during use.
- 

Carbon additives
The addition of carbon ensures faster charging, protection against sulfation and less electrolyte stratification. Thanks to the addition of carbon sulfates dissolve faster.
- 

Separator
High quality AGM separator: Extend cycle life and prevent micro short circuit
- 

High performance
High energy, low internal resistance, low self-discharge, no noise, easy to operate.
- 

Corrosion resistance
A special alloy improves the resistance of the plate against corrosion, increases service life and good deep discharge performance.

Terminals

M5

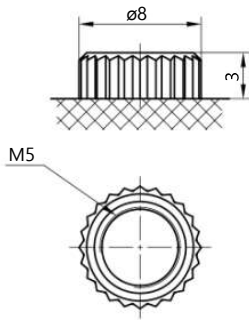

Terminal Torque Values in-lb(Nm):17.69-26.53(2.0-3.0)

Cycle life

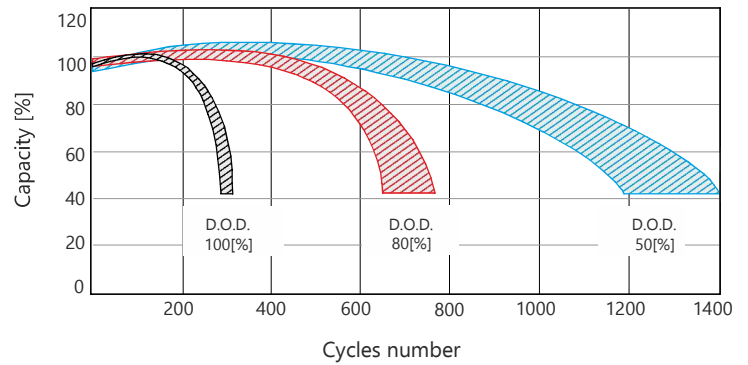

Dimensions

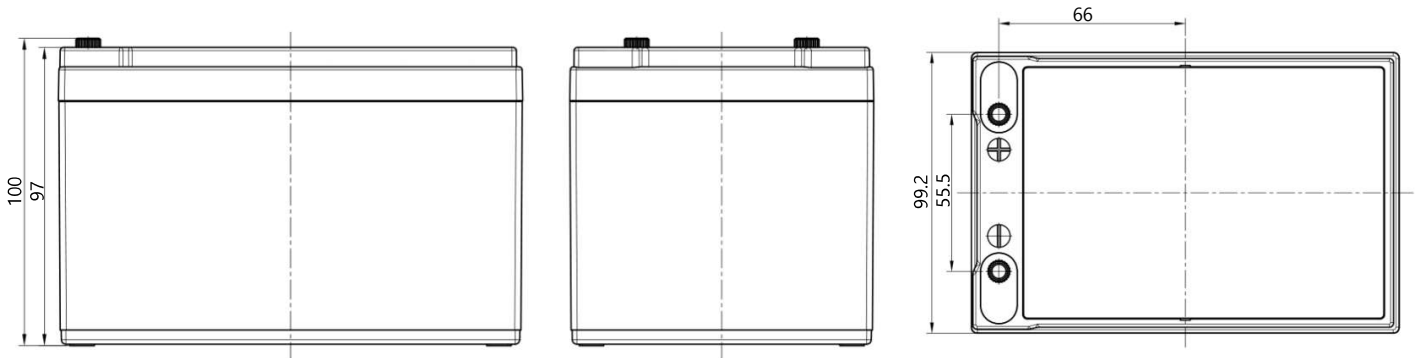

Environment information

Exploited batteries are considered as hazardous waste. These wastes due to their origin, chemical composition (they contains heavy metals like lead and other toxic substations) and other features may be dangerous for environment and human or animal health life. According to the waste act, waste in the form of batteries and accumulators should be collected separately from other types of waste.

In order to obtain more detailed information, we encourage you to contact us, we provide any information on how to handle with waste batteries and accumulators..

Safety



Recycling



Headquarters in Warsaw
Jana Kazimierza 61
01-267 Warszawa

Branch in Gdansk
Twarda 12
80-871 Gdańsk

+48 22 877 54 96
biuro@baterie.com.pl
www.baterie.com.pl

BP BATERIE
PRZEMYSŁOWE